

1 Introduction:

EHD Coercion water jacket heater consists of a water pump, heating element and a temperature intelligent control system, is designed for cooling liquid amount in 25-100 liters of engine. After install the heater, the engine coolant through the centrifugal pump cycle in between the heating jacket and engine, intelligent control systems will control the heating process, finally keep temperature of the coolant at the set range. Then the engine starting ability will upgrade, reducing startup losses, reduce wear and save fuel. Feature:

- I Microcomputer temperature control
- I LED display temperature and working status
- I Precision die-cast aluminum water jacket case
- I Additional rubber sleeve to reduce thermal losses
- I Configurable temperature control range
- I Fully protected to reduce potential damage and make sure continuous running
- I A discrete input used to remote control ON / OFF
- I A fault status dry contact output

2 Shape and installation dimensions:

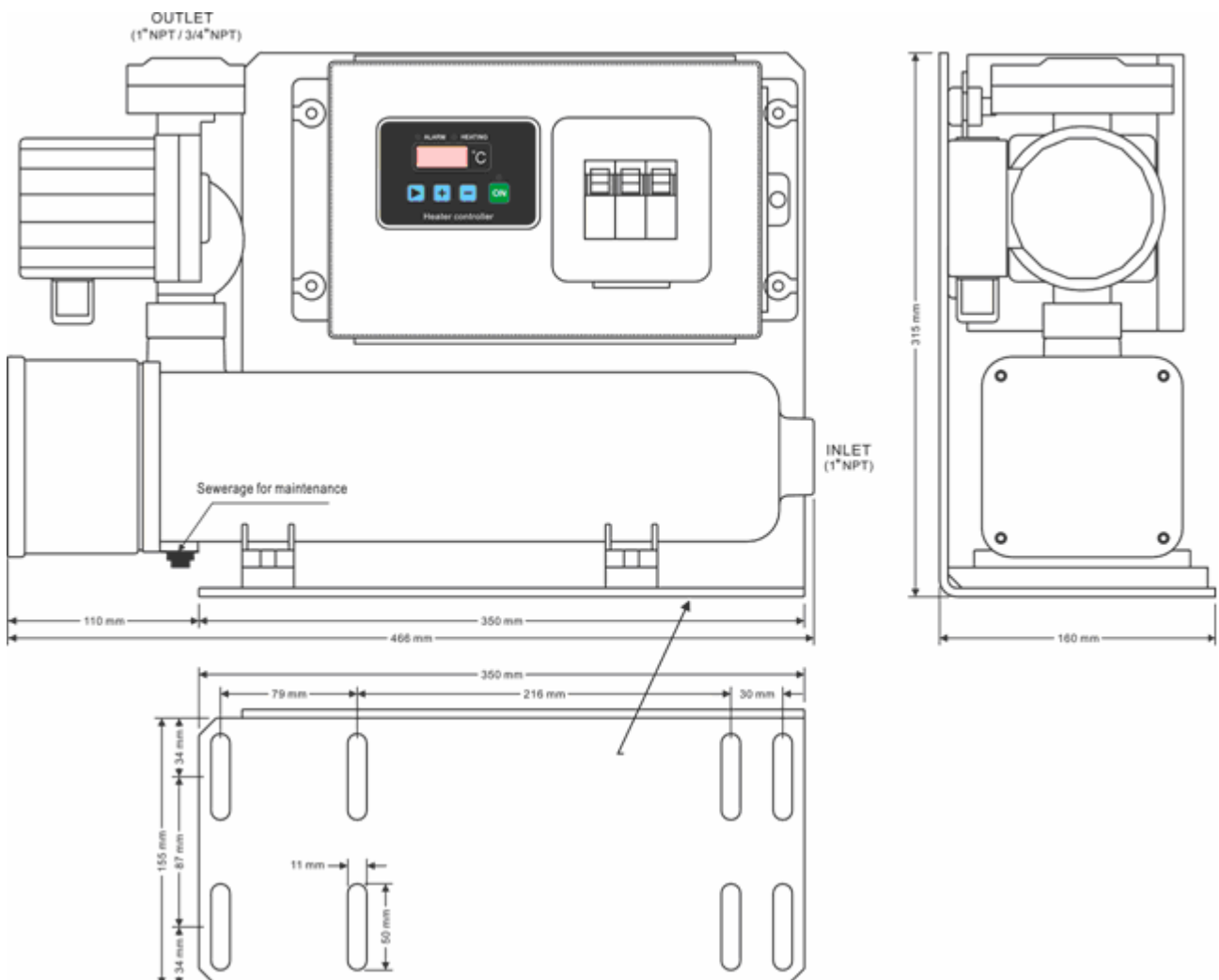

3 Wiring and electrical schematics:

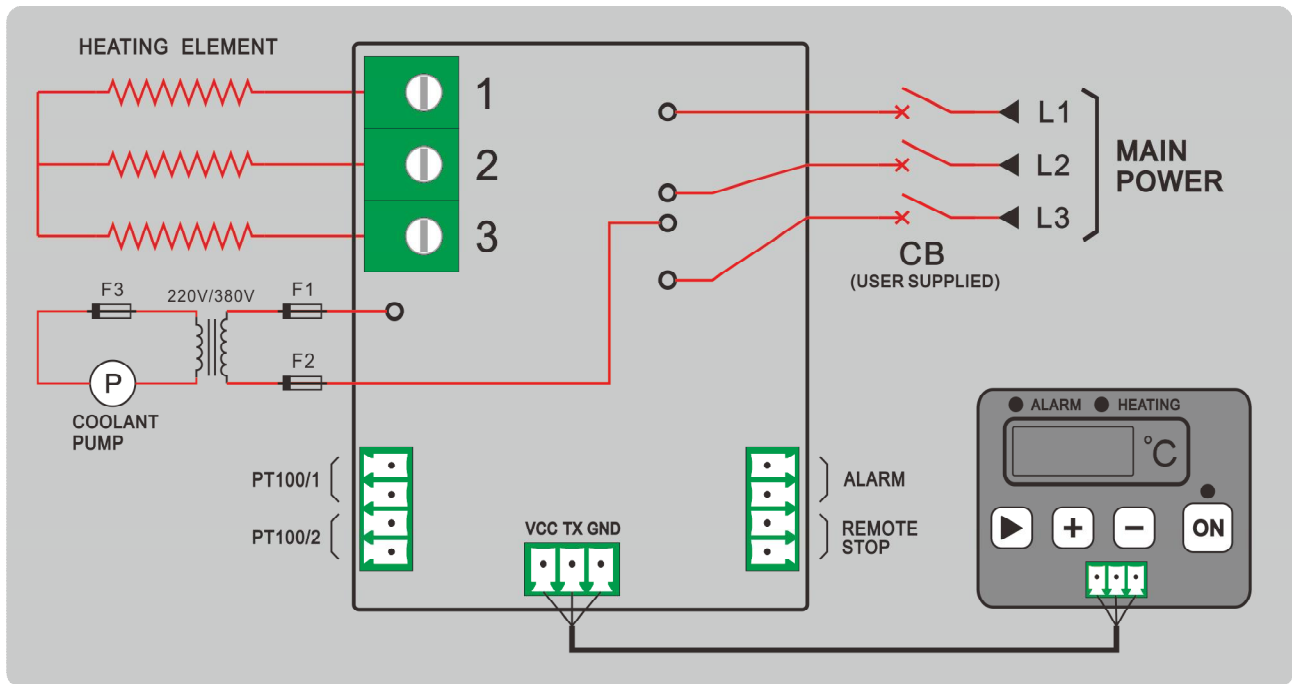

4 Installation

Installed correctly is very important for the normal work of the heater, otherwise it will damage the heater.

Position:

- I Must be mounted horizontally.
- I Isolation the engine vibration.
- I The heater water-jacket is setting in low position as far as possible below the engine cooling fluid.

Electrical connections:

- I Refer to the above wiring diagram
- I Must provide the good ground to ensure that the heater effectively grounding protection
- I User according to the power of the heater, select the appropriate main power circuit breaker to ensure the effective heater overcurrent protection.







Warning:

- I Heater installation and maintenance must be disconnected from the main power supply.
- I Must be installed and maintained by qualified engineers.
- I During transport and parking, if the ambient temperature causes the coolant in the heater water jacket to solidify, the coolant must be drained cleanly using the maintenance drain beforehand.

5 Operating instructions

Operating buttons and LED

Functional Description	Name
Setting Continuous press this button 2 seconds to enter / exit parameter setting menu.	
“+” Value Increase When in parameters setting mode, this button is used to increase value.	
“-” Value Decrease When in parameters setting mode, this button is used to decrease value.	
START / LED When the preheater switch on power, press the start button, the indicator lights is on, the preheater into the automatic heating and protection of the work process. Cycled state is holding.	
Alarm (FAILURE) LED When the preheater is detected any one of the pump failure, sensor failure, high temperature failure, the indicator light flashes.	● ALARM
Heating LED When the heating pipe working power relay is closed, the indicator illuminate; when the heating pipe work power relay disconnect, the indicator light not illuminate.	● HEATING

Control process:

When the preheater switch on power, press the start button, the indicator lights is on, the preheater enter into automatic heating working process, pump power relay is closed, the pump run for 60 seconds, if the jacket water temperature is higher than the **high limit temperature** setting value, the pump stops; if jacket water temperature is lower than the **high limit temperature** setting, heating pipe work power relay is closed, heating is started until the jacket water temperature is higher than the **high limit temperature** setting, heating pipe work power relay disconnect after the pump continue to run 60 seconds then stop.

After the pump stops running, the controller continues to detect the temperature of the water jacket, temperatures below the **lower limit temperature** setting value, the pump starts to run, after 60 seconds, if the temperature is higher than the **lower limit temperature** setting value, the pump is stopped, so the cycle. Until the pump run for 60 seconds, if jacket water temperature is below the **lower limit temperature** setting, heating pipe work power relay is closed, heating is started until the jacket water temperature is higher than the **high limit temperature** setting, heating pipe work power relay disconnect, the pump continue to run 60 seconds then stop. As above have been loop control process to ensure that the engine coolant temperature is always maintained within the setting range. Press the Start button to stop the automatic pre-heater make working process.

Protective function:

Sensor failure: If detected the sensors open or short circuit, after delay confirmation, fault indicator flashing, heating pipe work power relay disconnect, pump stop delay of 60 seconds, the digital display fault Code: A-02

Temperature fault: Any time the controller detects that the temperature sensor reaches 95 °C, fault indicator flashing, heating pipe work power relay disconnect, pump stop delay 60 seconds, digital display fault code: A-03. Failure is not locked until the temperature is below the **low limit temperature**, the fault indicator is off, continue to automatic control process。

Setting parameters: (Please enter the password first)

Low limit temperature: **Used to setting the temperature setting limits for starting heating.**

8888

High limit temperature: **Used to set setting stop heating limit temperature.** **8888**











(Factory default heating temperature control range is 38 °C to 49 °C)

LED digital parameter display:

After the power is turned on, the digital display of the measured temperature in the water jacket. Unit: °C

Setting:

Example: **8888** high limit temperature is 65 °C

Operation	Description
Press and hold  2 seconds to enter into the parameter setting menu, then displays the low temperature limit :	8888
Tap  scrolls to 8888 high limit temperature:	8888
Press  or  modify then PASS prompted for a password: enter 2213 (   )	8888
Press  or  can modify the parameters, then displays:	8888
Then press and hold  confirm and exit the modification	

6 Specifications:

Model	EHD3045	EHD3060	EHD3090	EHD3120
Voltage	415V (3P3W)			
Power	4500W	6000W	9000W	12000W
Current	6.3A	8.3A	12.5A	16.7A
Suitable coolant volume	10-25L	25-50L	50-75L	75-100L
Insulation resistance	10M Ω			
Voltage strength	1800V			
Pressure test	≥0.5Mpa			
Protection level	IP65			
Operating temperature range	-20 to 70°C			
Storage temperature range	-30 to 80°C			